

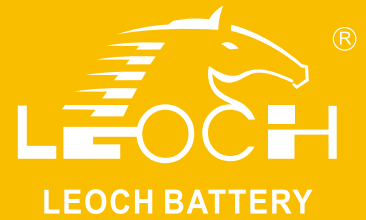

# LP Series-General Purpose LP12-200(12V200Ah)



## Specifications

Rated Voltage	12V	
Nominal Capacity	200.0Ah	(C <sub>10</sub> , 1.80V/cell)
Dimension	Length	522±2mm (20.55 inches)
	Width	240±2mm (9.45 inches)
	Container Height	218±2mm (8.58 inches)
	Total Height	224±2mm (8.81 inches)
Approx Weight	59.8 Kg (131.9 lbs)	
Terminal	M8	
Container Material	ABS	
Rated Capacity (25°C)	208.0 Ah	(20hr, 10.4A, 1.80V/cell)
	200.0 Ah	(10hr, 20.0A, 1.80V/cell)
	180.0 Ah	(5hr, 36.0A, 1.75V/cell)
	164.1 Ah	(3hr, 54.7A, 1.75V/cell)
	126.2 Ah	(1hr, 126.2A, 1.60V/cell)
Max. Discharge Current	2000A (5s)	
Internal Resistance (25°C)	Approx 3.2mΩ	
Operating Temp. Range	Discharge	-15 ~ 50°C (5 ~ 122°F)
	Charge	-20 ~ 40°C (-4 ~ 104°F)
	Storage	-15 ~ 40°C (5 ~ 104°F)
Nominal Operating Temp. Range	25±3°C (77±5°F)	
Cycle Use	Initial Charging Current less than 60.0A. Voltage 14.4V~15.0V at 25°C(77°F)Temp. Coefficient -30mV/°C	
	Initial Charging Current less than 60.0A. Voltage 13.5V~13.8V at 25°C(77°F)Temp. Coefficient -20mV/°C	
Standby Use	Initial Charging Current less than 60.0A. Voltage 13.5V~13.8V at 25°C(77°F)Temp. Coefficient -20mV/°C	
Effect of temp. to Capacity	40°C (104°F)	103%
	25°C (77°F)	100%
	0°C (32°F)	86%
Self Discharge	LP series batteries may be stored for up to 6 months at 25°C(77°F) and then a freshening charge is required. For higher temperatures the time interval will be shorter.	



## Layout

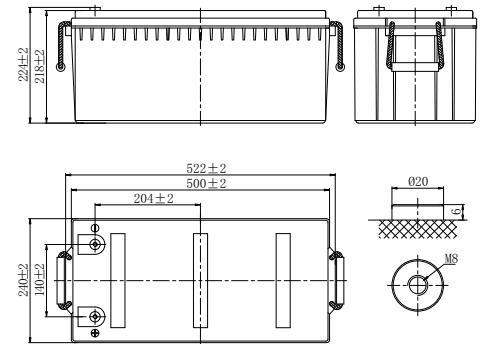

## Constant Current Discharge (Amperes) at 25 °C (77°F)

F.V/Time	10min	15min	20min	30min	45min	1h	1.5h	2h	3h	4h	5h	6h	8h	10h	20h
1.85V/cell	287.1	254.0	199.7	178.6	130.6	110.6	80.2	67.4	49.4	38.8	33.7	29.7	22.8	18.9	10.0
1.80V/cell	325.8	287.8	225.8	194.4	138.4	114.6	82.9	69.6	53.7	41.4	35.4	31.9	24.0	20.0	10.4
1.75V/cell	353.4	311.6	243.8	198.4	143.4	120.2	87.1	73.3	54.7	42.2	36.0	32.1	24.1	20.1	10.5
1.70V/cell	376.8	330.9	258.5	202.4	146.2	122.6	88.9	74.7	55.8	42.9	36.6	32.3	24.5	20.2	10.6
1.67V/cell	388.7	340.6	265.5	205.3	148.4	124.4	90.2	75.8	56.3	43.6	37.4	32.4	24.8	20.5	10.7
1.60V/cell	402.0	351.1	272.4	208.3	150.5	126.2	91.5	76.9	56.8	44.1	37.9	32.7	25.2	20.7	10.9

## Constant Power Discharge (Watts/cell) at 25 °C (77°F)

F.V/Time	10min	15min	20min	30min	45min	1h	1.5h	2h	3h	4h	5h	6h	8h	10h	20h
1.85V/cell	529.0	480.9	379.9	341.2	251.1	213.9	155.5	131.1	96.6	76.1	66.3	58.6	45.3	37.6	20.0
1.80V/cell	591.8	537.9	424.9	368.6	264.3	220.4	160.0	134.7	104.4	80.9	69.4	62.7	47.5	39.3	20.7
1.75V/cell	631.6	574.1	453.5	373.2	272.2	230.2	167.4	141.3	106.1	82.2	70.4	63.0	47.6	39.7	20.8
1.70V/cell	664.0	603.5	476.8	377.5	275.7	233.6	170.0	143.5	107.8	83.3	71.4	63.3	48.3	40.0	21.0
1.67V/cell	674.8	613.3	484.5	380.2	278.2	235.7	171.6	145.0	108.3	84.3	72.6	63.4	48.9	40.5	21.3
1.60V/cell	684.2	621.9	491.3	381.8	279.6	237.5	173.0	146.2	108.8	84.9	73.3	63.6	49.4	40.9	21.5



# LP Series-General Purpose LP12-200(12V200Ah)

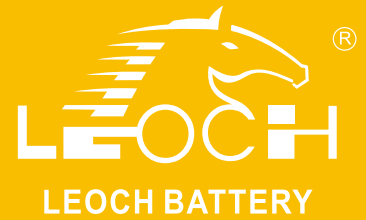

## Applications

- All purpose
- Uninterruptable Power Supply (UPS)
- Electric Power System (EPS)
- Emergency backup power supply
- Alarm and security system
- Communication power supply
- DC power supply
- Auto control system

## General Features

- 8 years design life(25°C)
- Special exhaust structure and sealing technology, safe and reliable, flexible installation, convenient maintenance
- PbCaSn alloy for plate grids: less gassing, less self-discharging
- High quality AGM separator: extend cycle life and prevent micro short circuit
- High purity raw material: ensure low self discharge rate

## Standards

- Compliance with IEC 60896 standards, EU Battery Directive
- UL, CE Certified
- Manufactured in Leoch®IATF 16949, ISO45001, ISO 9001 and ISO 14001 certified production facilities

## Discharge Characteristics

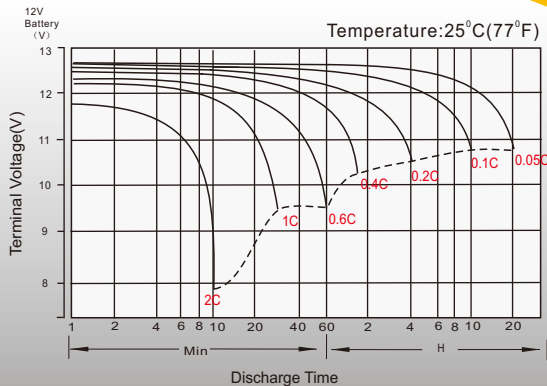

## Float Charging Characteristics

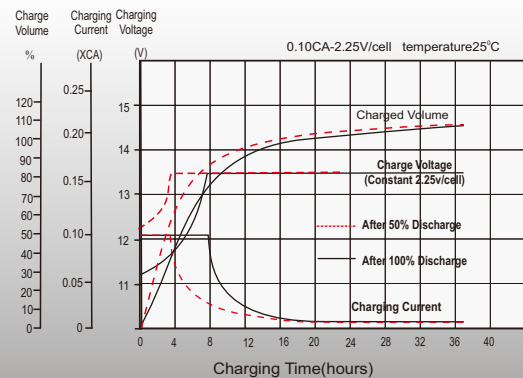

## Temperature Effects in Relation to Battery Capacity

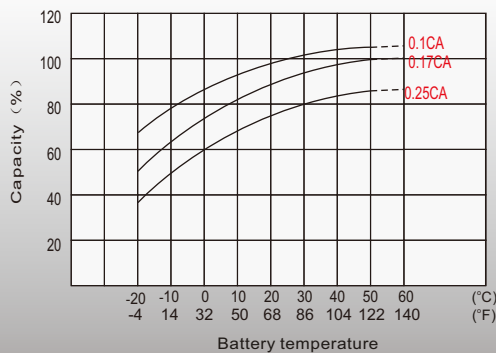

## Float Service Life

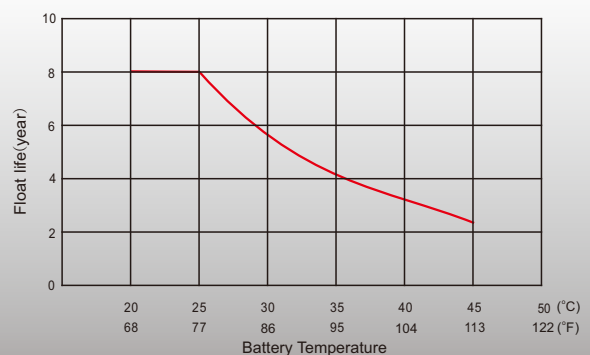

## Sales Offices Worldwide

### China Sales Office

5th Floor, Xinbaohui Bldg., Nanhai Blvd.,  
Nanshan, Shenzhen, China. 518052  
Tel: +86-755-86036060 (100 lines)  
Tel: +86-755-26067269  
E-mail: export@leoch.com

### HongKong Sales Office

Workshop C, 33/F, TML Tower, No. 3 Hoi Shing Road,  
Tsuen Wan, New Territories, Hong Kong  
Tel: +852 35786666  
Tel: +44(0) 1452 729428 / 1452 729696  
E-mail: sales.hk@leoch.com

### Singapore Sales Office

No. 1 Tech Park Crescent,  
Singapore 638131  
Tel: +65 68636078  
Tel: +65 6863 6079  
Email: sales.sg@Leoch.com

### Australia Sales Office

2 /29 Tarlington Place, Smithfield. NSW 2164  
Australia  
Tel: 02 9756 0950  
E-mail: sales.au@leoch.com

### North America Sales Office

19751 Descartes  
Foothill Ranch, CA 92610, USA  
Tel: 949-588-5853  
Tel: 949-588-5966  
E-mail: sales@leoch.us  
Http:// www.leoch.us

### UK Sales Office

9B Wheatstone Court. Waterwells, Business Park,  
Gloucester, GL2-2AQ, UK United Kingdom  
Tel: +44(0) 1452 729428 / 1452 729696  
Tel: +44 1452 690125  
E-mail: Sales.Europe@leoch.com  
Http:// www.leoch.eu

### EMEA Sales Office

1 Deligiorgi St., 121 31 Athens,  
Greece  
Tel: +30 210 5760318 (2 lines)  
Tel: +30 210 5760318 (2 lines)  
E-mail: support\_EMEA@leoch.com  
Http:// www.leoch.eu

### India Sales Office

Shed no.A-53(b), 2nd Stage of Peenya Industrial Area,  
Bangalore North Taluk, Bangalore-560058, India  
Tel: +91-80-23440018/23440019  
Tel: +91-80-23440017  
E-mail: indiasales@leoch.com



[Http://www.leoch.com](http://www.leoch.com)

© 2020 LEOCH. All rights reserved.

Trademarks and logos are the property of LEOCH and its affiliates unless otherwise noted.  
Subject to revisions without prior notice.

Publication No.: LB-LP12-200-PD-EN-V2.0-202004